

## SPECIFICATIONS

### 30" Sedona Vanity Top

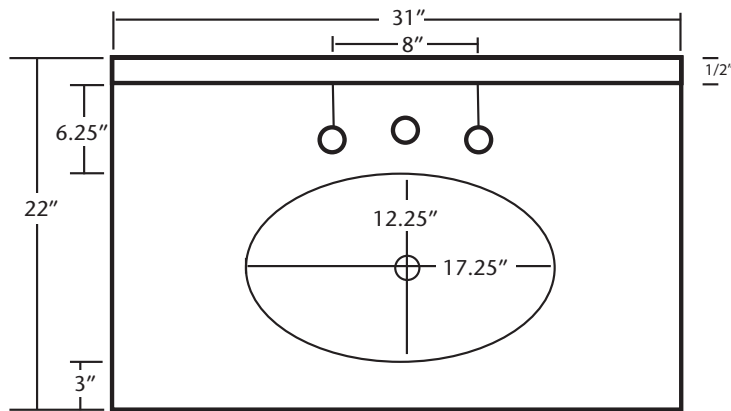

VNT302- Antique  
VNT305- Brushed Nickel

#### PRODUCT DETAILS

- \* 31" x 22" OD
- \* Hand hammered 16 gauge recycled copper
- \* 3.5" Backsplash
- \* Basin: 17.25" x 12.25" x 5.25"
- \* Pre-drilled for 8" faucet spread
- \* Dimensions are not exact and may vary  $\pm 1/2"$

#### COORDINATING PRODUCTS

- \* Drains: DR120, DR150 or DR160
- \* Sedona Mirror



#### IMPORTANT

Due to the handcrafted nature of this product, it will vary in finish, texture, hammering, and other details. Dimensions may vary up to 1/2".