

SPECIFICATIONS

24" Cuzco Vanity Base

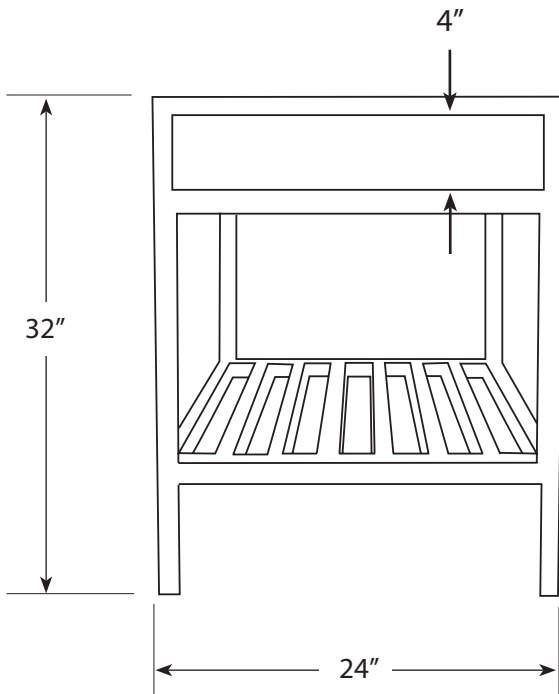

FEATURES

- * 24"w x 21.5"d x 32"h
- * Iron with hand hammered copper accent panels

FINISHES

- * Antique Finish - VNR242
- * Brushed Nickel Finish - VNR245

INSTALLATION

- * Freestanding base (top sold separately)

COORDINATING ACCESSORIES

- * Tuscany and Sedona vanity tops

IMPORTANT

Due to the handcrafted nature of this product, it will vary in finish, texture, and other details. Dimensions may vary up to 1/2".

